

1/32 SQUARE & SHEET
STABILIZER

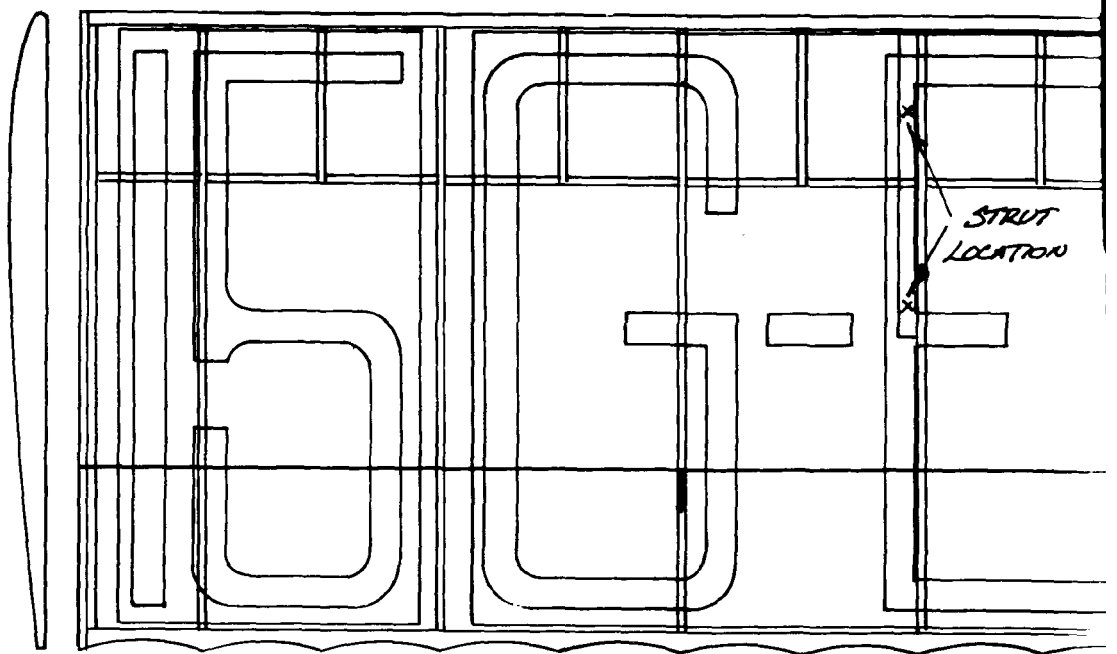
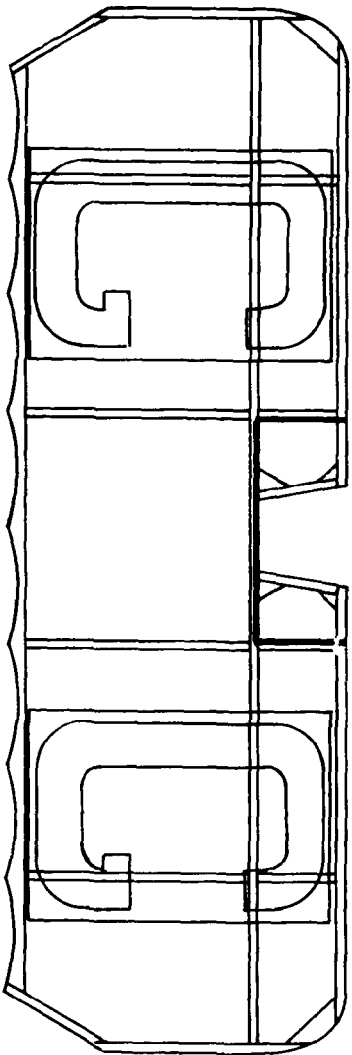

1/32 SHEET
TIP RIB

1/16 SHEET
(HARD)

1/16 x 1/8 LEADING & TRAILING

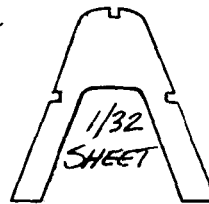

CONSTANT
RADIUS

1/16 SHEET NOSEBLOCK

1/4 SHEET PLUG

1/16 BRASS BUSHING

1/20 SHEET FILL

SECTION

1/32 SHEET

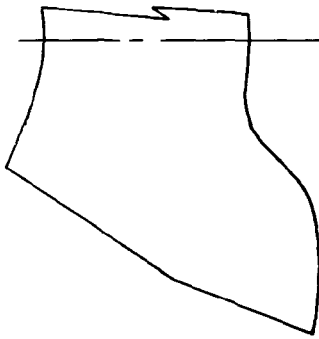

HOLLOWED FOAM
FUEL TANK
(BRASS)

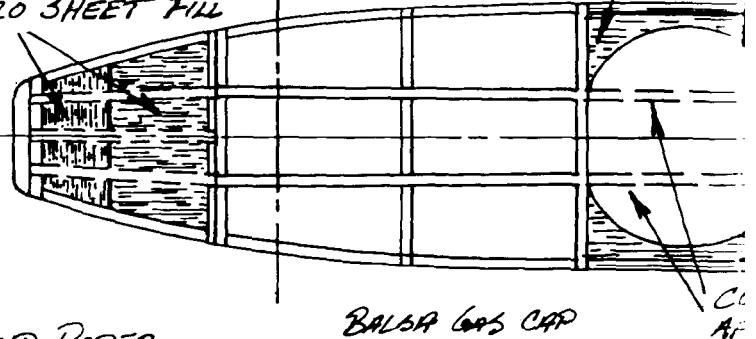

BOND PAPER
TOP & SIDE
COWLING PANELS

BALSA GLUE CAP
TISSUE STRIP

BRITISH
ANZANI

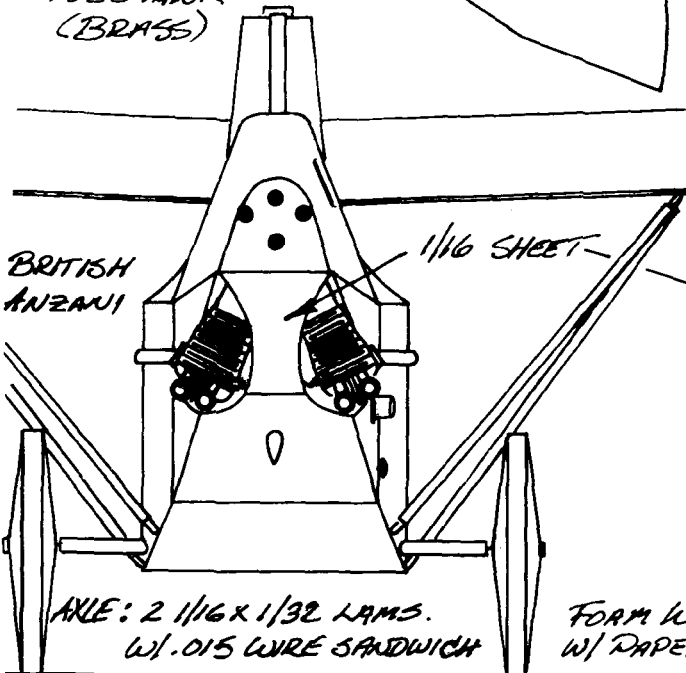

1/16 SHEET

AXLE: 2 1/16 x 1/32 LAMS.
W/ .015 WIRE SANDWICH

FOAM WHEELS
W/ PAPER DISCS

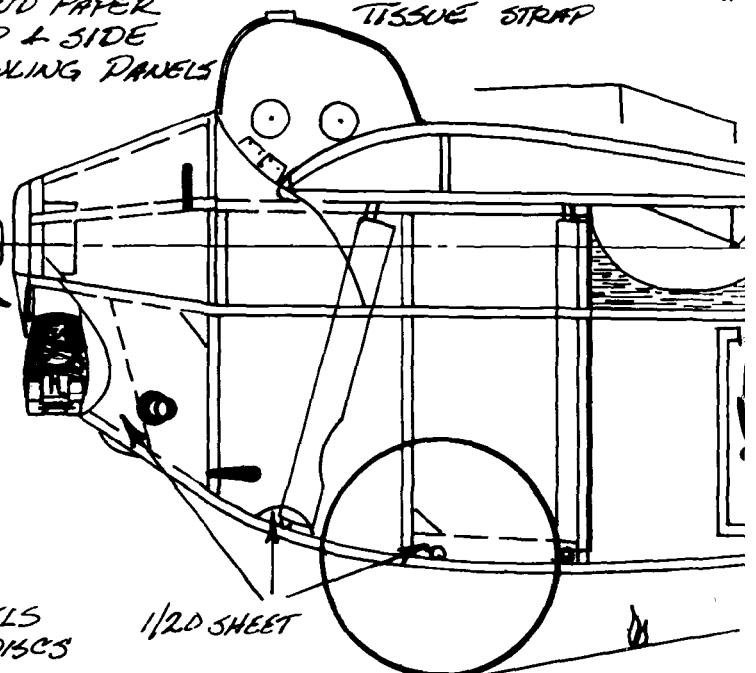

1/20 SHEET

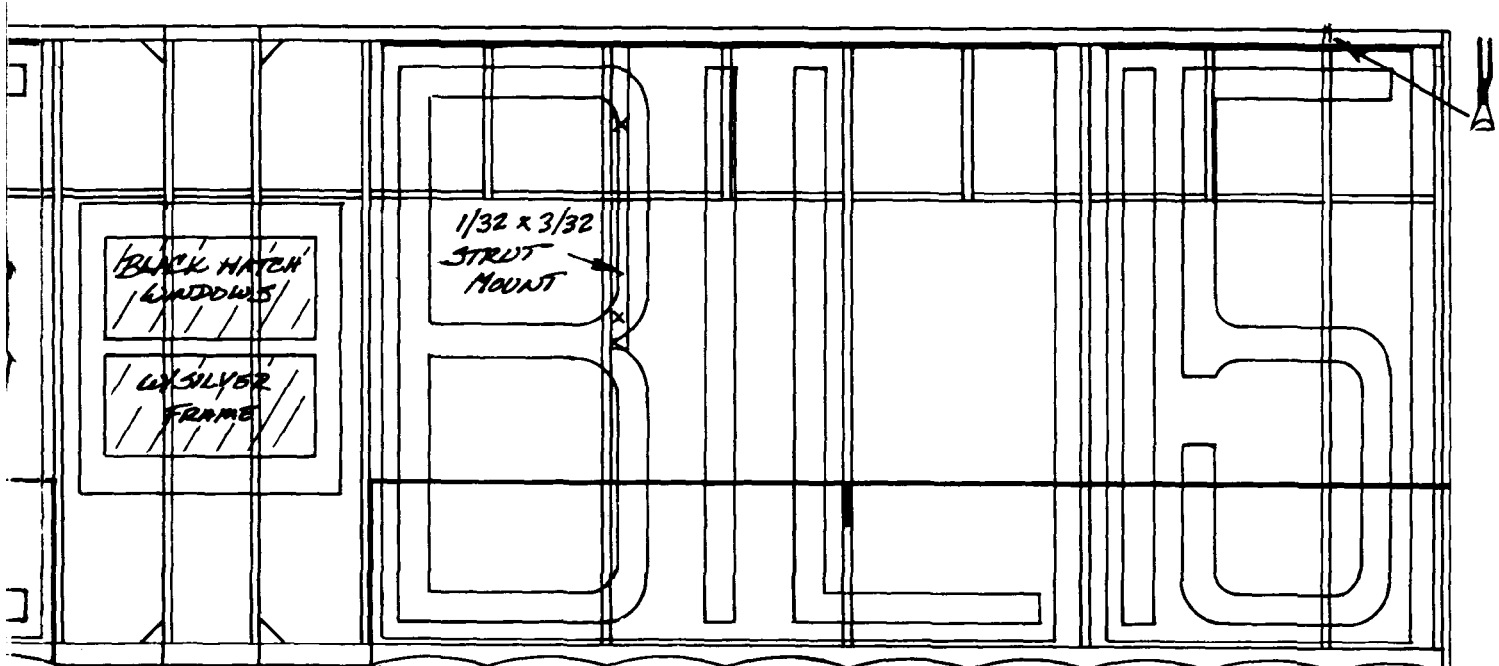

KG EDGE

WHITE FIELD

WHITE FIELD

ALL MARKINGS TOP & BOTTOM

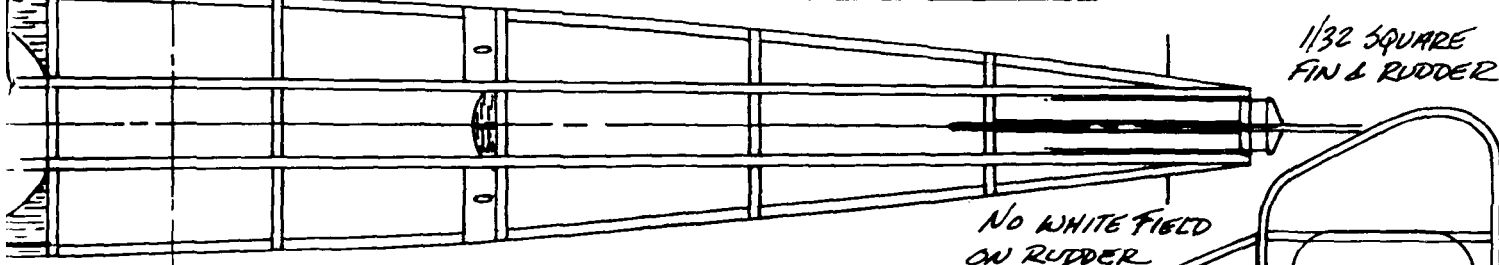
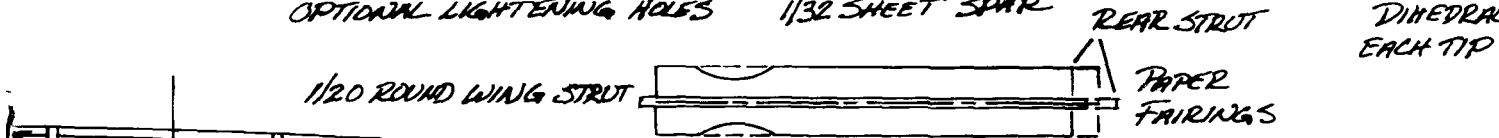
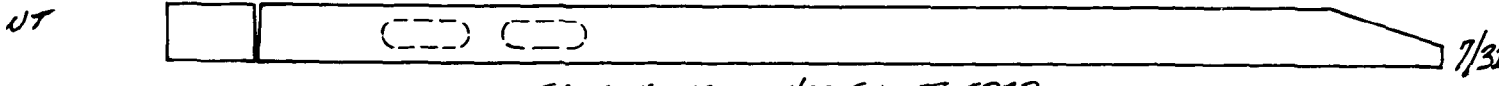

AT OUT
TER ASSY.

COLOR SCHEME: OVERALL SILVER W/BLACK MARKINGS ON WHITE FIELDS

REFERENCES: "ULTRALIGHTS" (RIDING) P43
AIRCRAFT ILLUSTR. OCT '69 P392

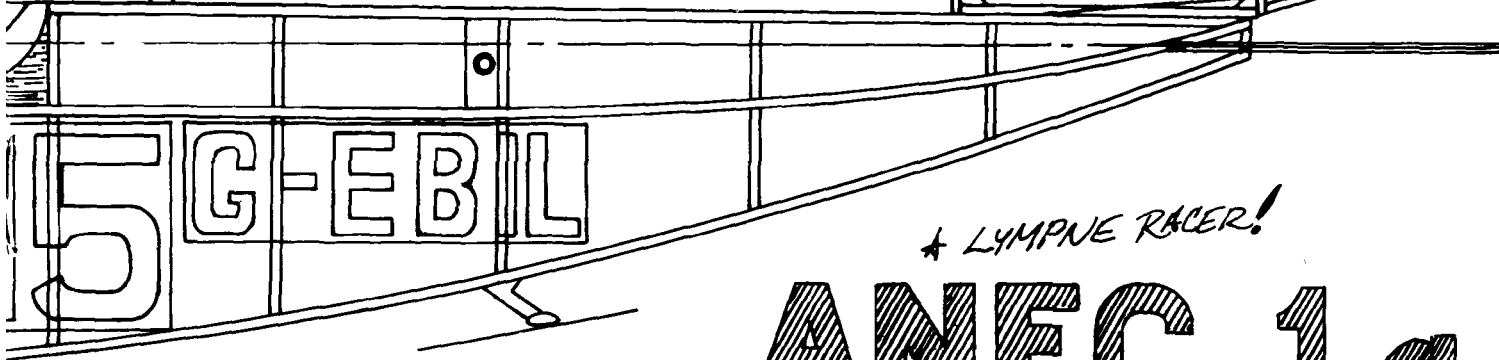

FUSELAGE ALL $1/20$ SQUARE

* LYMPNE RACER!

ANEC 1a

T.E. NALLEN II 1992