

\* COLOR SCHEME:  
WHITE WITH RED  
TRIM & NUMBERS

1/8" SQ. LF.

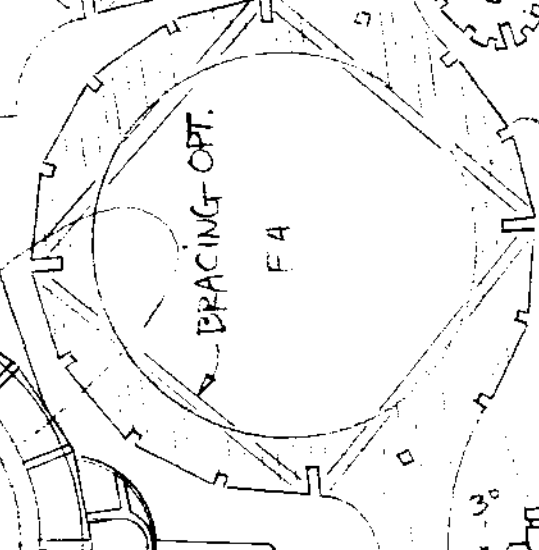

\* ALL STRINGERS  
1/20"

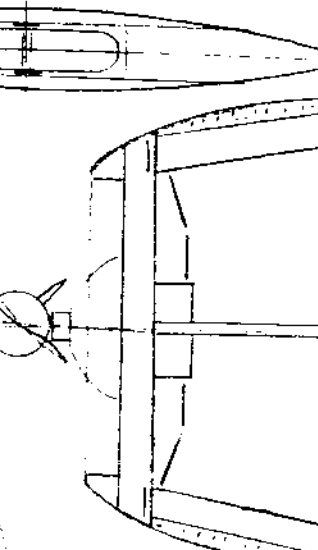
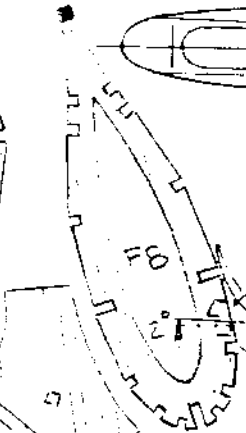
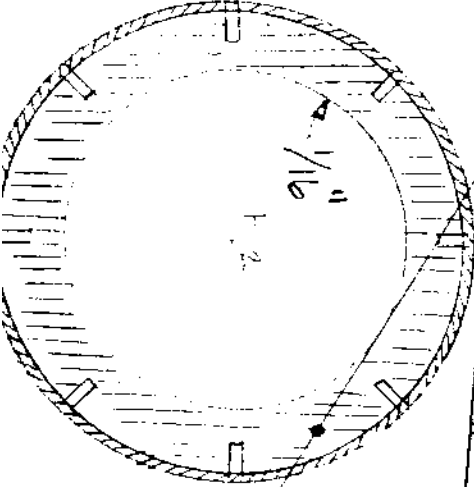
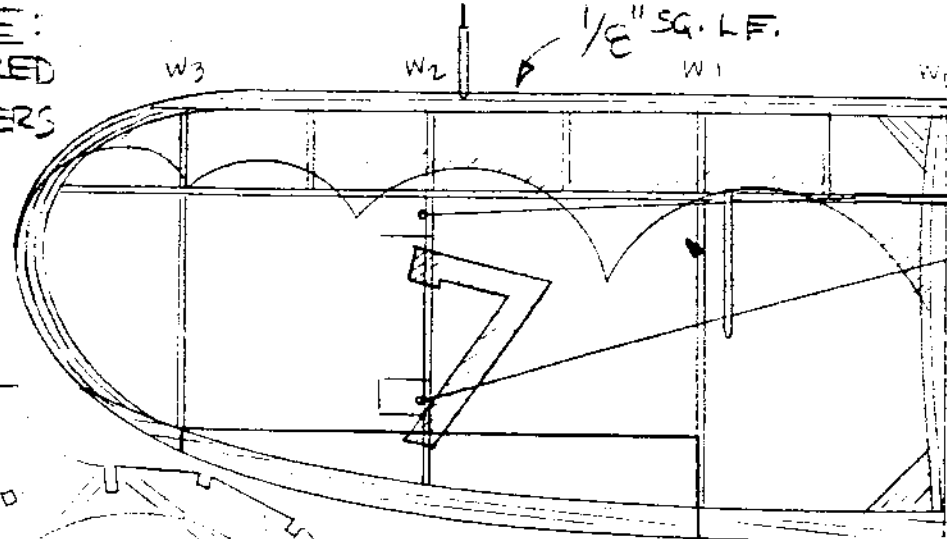
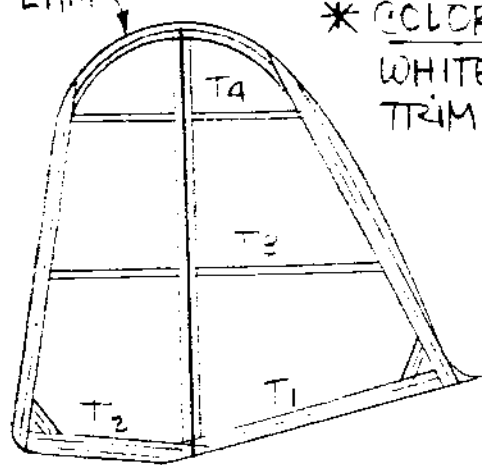
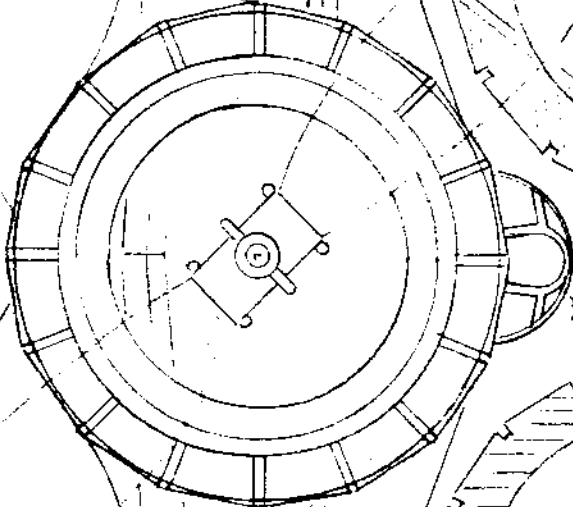
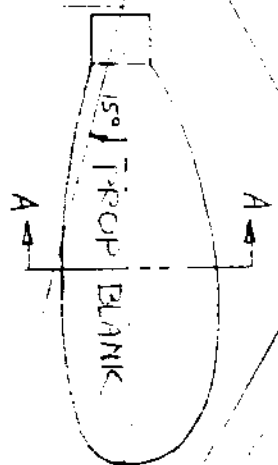

\* BULKHEADS:  
1/32"

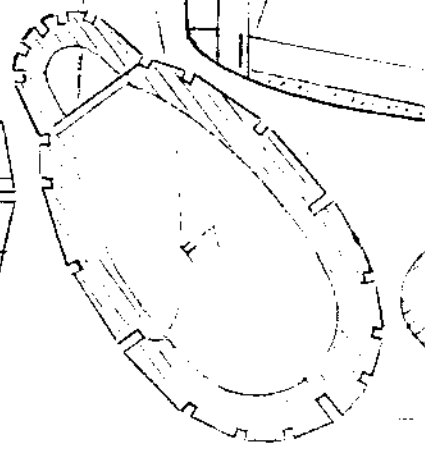
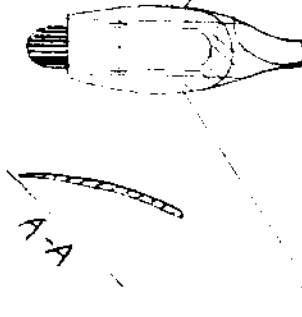
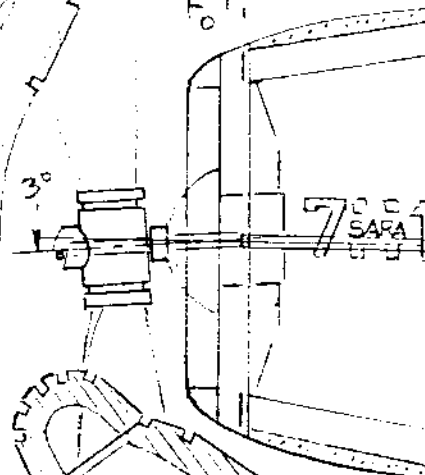
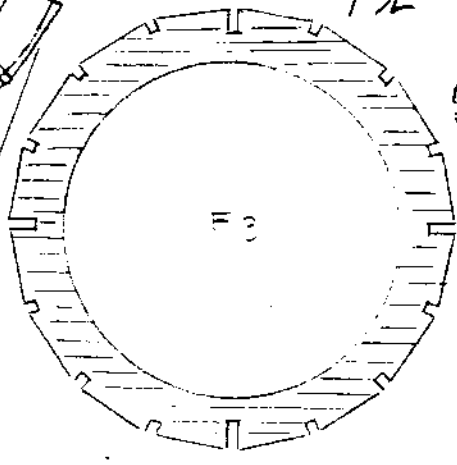

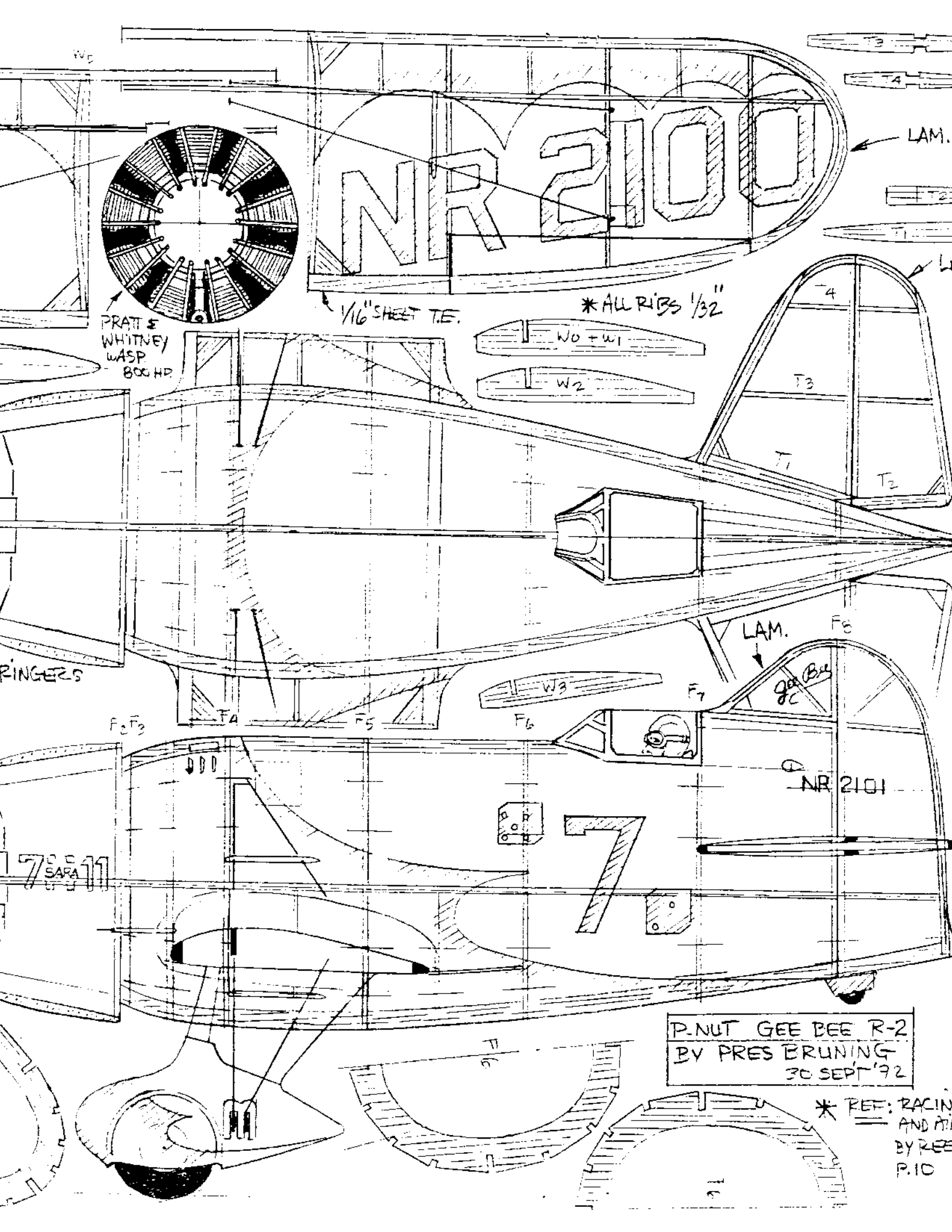

1/16" SHEET T.E.

\* ALL RIBS 1/32"

PRATT & WHITNEY  
WASP  
800 HP

RINGERS

700 SARA 11

LAM.

NR 2101

P. NUT GEE BEE R-2  
BY PRES BRUNING  
30 SEPT '92

\* REF: RACING  
AND PI  
BY REE  
P. 10

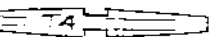
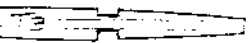

LAM.

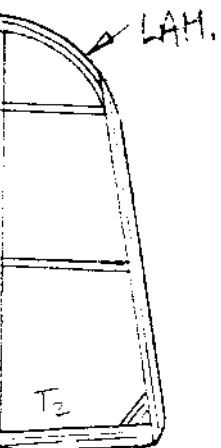
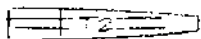

R-2  
NG  
T '92

REF: RACING PLANES  
AND AIR RACES  
BY REED KINERT  
P. 10